



infiniti **fires**

a new generation in heating



fireplaces



INFINITI Fires Fireplaces

The INFINITI range of superior fireplaces is the result of meticulous research around consumer requirements in both fashion and function. A group of fireplace industry specialists believed that a truly South African fireplace product, embodying the best of local and international design and using the best quality raw material available, was possible. The realised intention was striking style and realistic flames, a product which, as a décor piece, enhances your home and, in function, achieves one of the most fuel efficient heating figures of any comparable product.

Flexibility into the Future

The INFINITI range allows exceptional flexibility of product choice, so you are able to style your INFINITI fireplace to suit your personal taste, whether rustic or ultra modern. The INFINITI range is built on standard high quality fireboxes on which you can fit a range of trim and grate options.

Frames and grates are interchangeable at any time, allowing you the versatility of being able to change the look at any time in the future without having to change the firebox.

For the developers selling off plan this is a real bonus. The firebox can be built in during the construction stage and the house owner can make their choice of the styling options just before they move in.

Combustion Efficiency

INFINITI fireplaces are highly advanced in their environmental friendliness and combustion efficiency. Carefully researched design maximises the best possible thermal transmission of heat from the fireplace into your room.



INFINITI 700 Flued Gas Fire with Deluxe Stainless Steel Frame and White Pebbles

The INFINITI Gas Fireplace

INFINITI produces both flued and flue-less gas fires. Front dimensions of the fireboxes are kept consistent so that all trim options will fit either type of gas fire.

Whether you choose flued or flue-less gas, you choose an option packed with advantages.

FLUED GAS FIRES disperse a lot of their heat up the chimney. This lower heat efficiency is however balanced with a zero fume dispersion into the room. This means that the flued gas fire is completely odourless. The construction of the flued unit ensures the most natural looking flame pattern in a non wood-burning unit. Furthermore, in the INFINITI fireplace range, the INFINITI gas flued fireplace is one of the lowest gas consumption models available if compared to similar products on the market.

Available in 700mm single sided version.

FLUE-LESS GAS FIRES are without a chimney and are therefore considerably more fuel efficient. In the INFINITI gas fireplace range, with a uniquely designed combustion system, they reach heating efficiencies of close to 100%. This makes the flue-less fireplace units superb for the economical heating of large spaces. And of course the units are perfect for installation into rooms or houses without chimneys.

INFINITI flue-less gas fires are available in:

- Single sided built in units, ideal for the larger room
- Double Sided built in units, ideal as a feature between two living areas
- Both single and double sided versions are available as either a 700 or 1000mm wide unit.
- Wallmounts, easy to install, designed to put at picture height on the wall to create a heating feature.

Safety Comes First

All INFINITI gas fires are equipped with flame failure devices. This ensures that the gas supply is automatically switched off should the pilot light cease burning.

INFINITI flue-less gas fires also have an oxygen depletion sensor which will switch off the fire if it detects a low level of oxygen in the room.

These safety devices make these units very safe to use.

INFINITI flue-less gas fires have recorded CO/CO² ratios of approximately 30% of the maximum legal/safe limit set by the authorities in South Africa. These low figures put them at the forefront of technology in South Africa which guarantees not only their safe usage but also a virtually odourless operation, an essential component of a superior flue-less gas fire.



INFINITI 1000 Flue-less Gas Fire with Extra Wide Stainless Steel Frame and White Pebbles



INFINITI 1000 Double Sided Flue-less Gas Fire with Wraparound Black Trim and Coal Effect Fire

The INFINITI Wood Fire

The INFINITI wood burning fire utilises a parabolic back wall, with heat radiating fins to enhance the heat output from the fire through the highly efficient convection system. A concealed ash tray keeps the fire looking good and enables easy cleaning.

Available in a 700mm single sided version.



INFINITI Wood Burning with Deluxe Black Trim

The INFINITI WallMOUNT

Unique Installation Benefits

Installation of the INFINITI WallMOUNT requires no messy building work and no costly alterations. The WallMOUNT frame bolts firmly to the wall at three points, with minimal disturbance to the inside of your home. Installation is also speedy. If the unit gas bottle is located within a few meters of the WallMOUNT, complete installation can be achieved in about 90 minutes.

This means that installation of the INFINITI WallMOUNT is quicker and cheaper than other flue-less fires, most of which require some form of building or structural alterations. This saves time, limits installation mess, and reduces the material and labour costs related to such alterations.

The WallMOUNT unit is intended to be installed at 900mm above floor level, maximising thermal transmission into the room, and safely protecting little hands and bodies from the heat of the fire, eliminating the need for a fire screen.



INFINITI WallMOUNT Black

Styling Choices

The INFINITI WallMOUNT is available in trendy Stainless Steel or Black, each with the following choice of styling:

- Coal and Black Chips
- Coal and White Chips
- Black Chips
- White Stone and Black Chips
- White Stone and White Chips



INFINITI WallMOUNT Stainless Steel



Single-Sided Built in Fires

Wood and Flued Gas Boxes

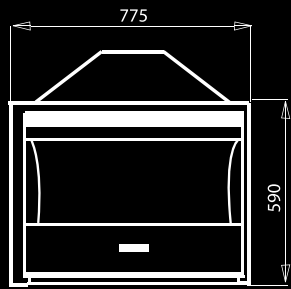

Standard box

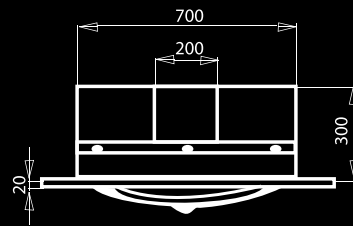

Plan view

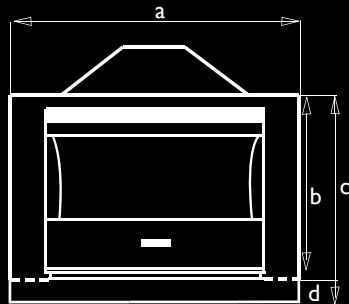

Standard box with frame

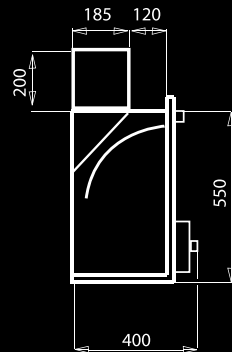

Side view

700 Box Size	a	b	c	d
Standard Box	775	590	590	0
Deluxe Frame	935	595	595	0
Extra Wide Frame	1190	595	595	0
Wraparound Frame	1165	618	672	54
1000 Box Size not Available				

Styling Choices



INFINITI Standard Black



INFINITI Deluxe Black Frame



INFINITI Extra Wide Black Frame



INFINITI Wraparound Black Frame

Flue-less Gas Boxes

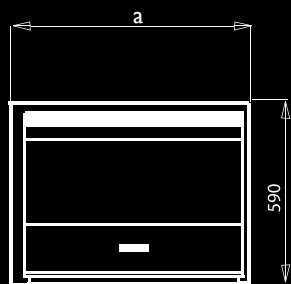

Standard box

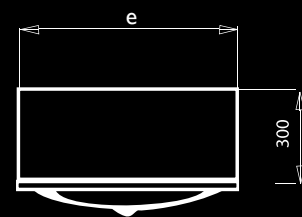

Plan view

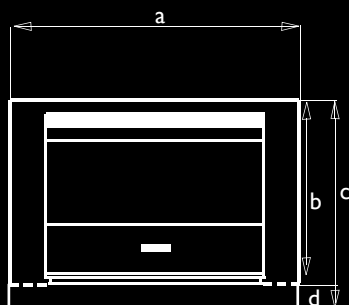

Standard box with frame

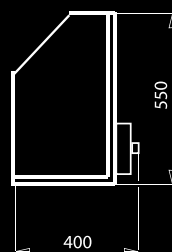

Side view

700 Box Size	a	b	c	d	e
Standard Box	775	590	590	0	700
Deluxe Frame	935	595	595	0	700
Extra Wide Frame	1190	595	595	0	700
Wraparound Frame	1165	618	672	54	700
1000 Box Size	a	b	c	d	e
Standard Box	1075	590	590	0	1000
Deluxe Frame	1238	598	598	0	1000
Extra Wide Frame	1455	621	621	0	1000
Wraparound Frame	1460	621	675	54	1000

Styling Choices cont.



INFINITI Deluxe Stainless Steel Frame



INFINITI Extra Wide Stainless Steel Frame



INFINITI Wraparound Stainless Steel Frame

The INFINITI Choice Make it the way you want it

Fire Box Choices:

- 700 size - Thicker solid fuel (wood) burning unit
- 700 size - Flued (chimney) gas fire
- 700 or 1000 size - Flue-less gas fire, single or double sided

Frame Choices:

- Standard 40mm frame - Black
- Deluxe frame - Black or Stainless Steel
- Extra Wide frame - Black or Stainless Steel
- Wraparound frame - Black or Stainless Steel

Gas Fuel Effect Choices - Flued & Flue-less

	Flued	Flue-less
White pebbles	✓	✓
Coals	✓	✓
Logs	✓	—

REMEMBER: Finishes and grate choices are interchangeable at any time. However, the initial box choice defines the alternatives available. Flue-less gas cannot be adapted to flued gas, and flue-less or flued gas cannot be adapted to solid fuel.

Double-Sided Built in 700 or 1000 Size Flue-less Gas Fire

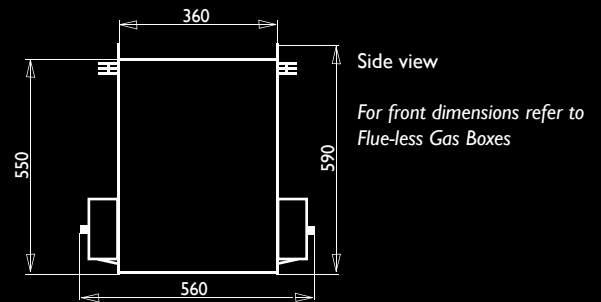

WAlIMOUNT Fires

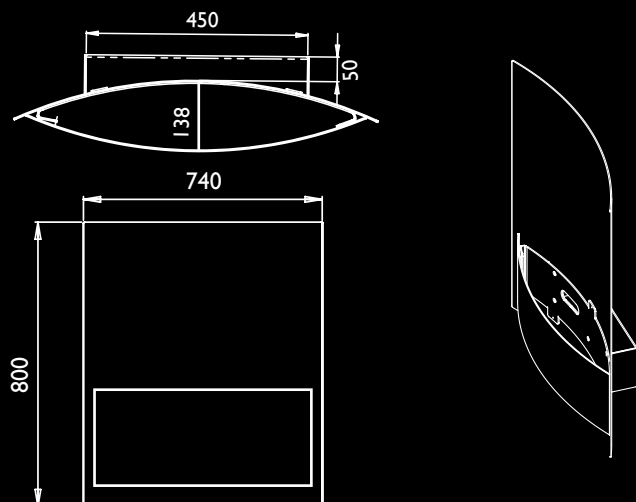

Styling Choices



Unequaled Features of the INFINITI Fireplace:

- Advanced convection and exceptional heating efficiency on all units
- Low fuel consumption
- 95% or more heating efficiency on flue-less units
- Wide range of adaptable solid fuel, flued and flue-less units
- Frame, grate and gas effect choices to ensure complete personal selection
- Unique burner design on flue-less units
- Flame failure and oxygen depletion sensors built into the gas grates ensure optimum safety
- Locally manufactured box and grate ensuring easy parts and back up service availability
- Flued units are especially designed to allow easy cleaning of the chimney through the larger than normal vent holes
- 15 years warranty on the fire boxes
- 2 years warranty on the gas grates
- Double Sided units are a slim 360mm between faces to allow easy retro fitting through existing walls

Specifications

Unit	Heating Capacity	Gas Consumption (g/hr)	
		Lo	Hi
700 Wood-burning	130m ³	-	-
Wallmount	90m ³	140	210
700 Flued Gas Pebble effect	90m ³	450	700
700 Flued Gas Coal effect	120m ³	400	600
700 Flued Gas Log effect	130m ³	400	750
700 Flue-less Single sided	300m ³	400	650
700 Flue-less Double sided	420m ³	600	900
1000 Flue-less Single sided	400m ³	500	850
1000 Flue-less Double sided	450m ³	550	970

